

# Identification and Classification of Aquatic Microorganisms

## FlowCAM: An imaging Particle Analysis System

Since its first introduction in 1999, FlowCAM has become a valued and accepted piece of instrumentation for oceanographic and freshwater research. With over 150 instruments installed worldwide in these applications to date, in prestigious laboratories such as Scripps Institution of Oceanography, Alfred Wegner Institute, Bigelow Laboratory for Oceanographic Sciences, Laboratoire d'Océanologie de Villefrance, and the Chinese Academy of Sciences, the value of FlowCAM in research keeps growing. In addition to characterizing both phytoplankton and zooplankton, FlowCAM is also being used for HAB monitoring, water quality monitoring of source drinking water (taste and odor algae), algal research and production for biofuels, and ballast water research. With continuous product improvements

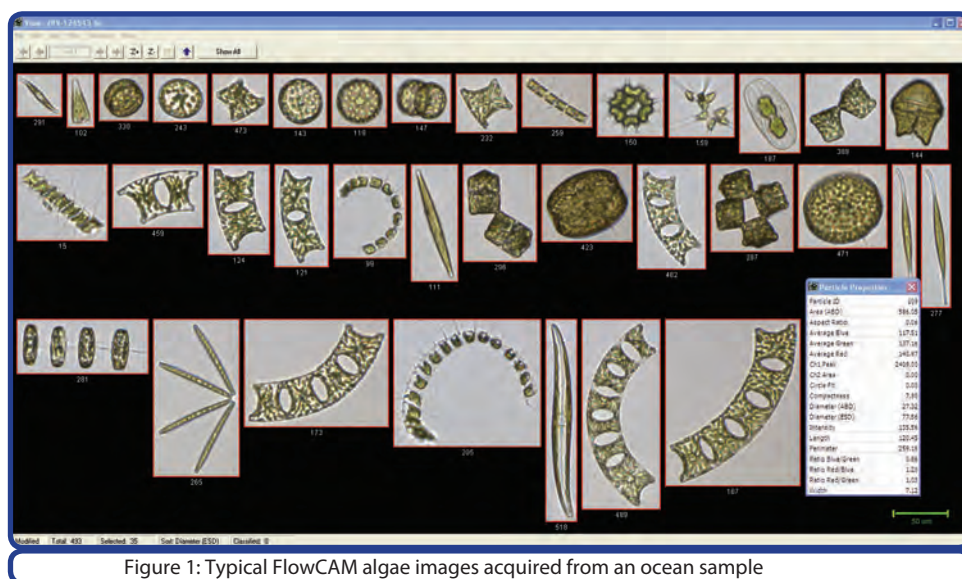

Figure 1: Typical FlowCAM algae images acquired from an ocean sample



Figure 2: Benchtop FlowCAM

driven by customer input, the instrument continues to meet the expanding needs of the research community.

FlowCAM represents a combination of an automated microscope for detailed morphological analysis (size, shape, etc.) of algal cells with the ability to additionally add in fluorescence values to further discriminate cell types similar to a flow cytometer. A simplified block diagram is shown in Figure 3. The sample is pulled through a rectangular flow cell by a peristaltic (or optional syringe) pump). As the sample passes through the field-of-view (FOV) of the camera, a flash LED behind the flow cell provides back lighting. The camera is triggered synchronously with the

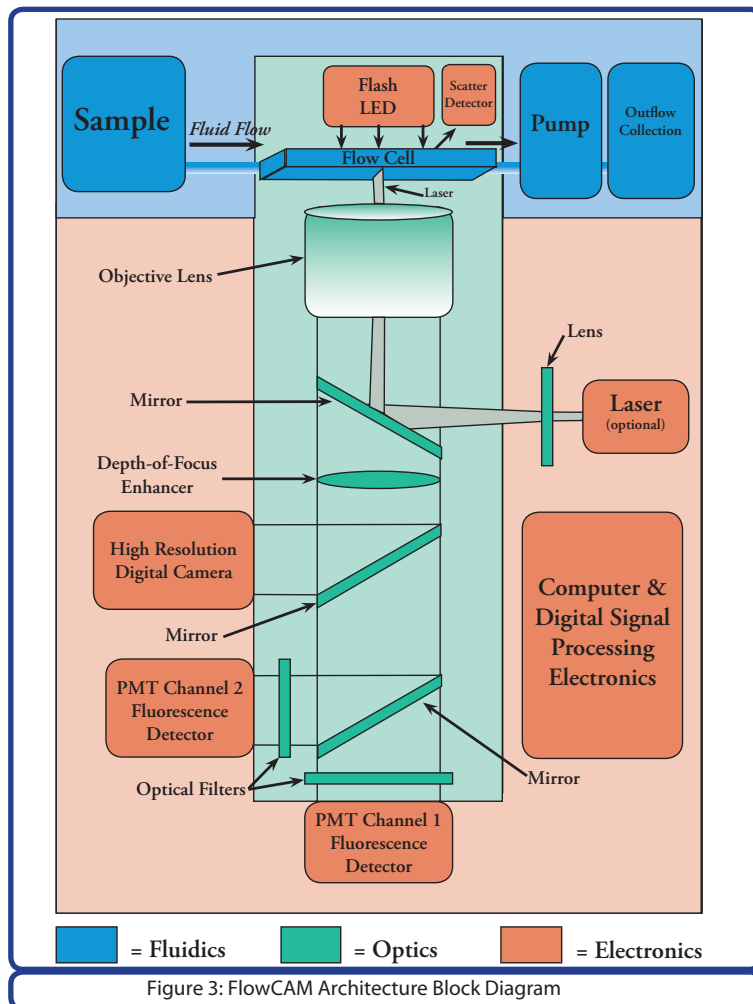

Figure 3: FlowCAM Architecture Block Diagram

flash, effectively “freezing” the sample for the camera to acquire the image of the flowing sample. Because FlowCAM does *not* use sheath fluid, it can accommodate a much wider range of particle size (up to 2,000µm) than other instruments.

When each image of the FOV is acquired, the VisualSpreadsheet® software thresholds each cell from the background, and only stores images of the cells themselves as individual images within a “collage”. Each image has indexed to it up to 26 different measurements which are made from the cell image as it is acquired. These measurements fall into several categories: “morphological” measurements such as diameter, length, width, perimeter, circularity, etc., “gray-scale” measurements such as intensity, transparency, color information, etc., and “spectral” measurements such as peak, area and width measurements from the signals collected in the two channels of fluorescence. The morphological measurements are ones that might be normally made by using a digital camera on a microscope, with the difference being that the measurements are being made on a moving stream of particles as opposed to a static microscope slide. This means that FlowCAM can acquire and measure thousands of particles per minute, thereby collecting far more data automatically, yielding higher statistical significance.

The unique advantage of FlowCAM is that it relies primarily on “morphological and gray-scale discrimination” of algal cells as opposed to “spectral discrimination” typical of a flow cytometer. However, because of the fluorescence capabilities of FlowCAM, spectral data can be used along with the morphological data to further discriminate algal cells. This overcomes a significant limitation of flow cytometers, which only have a single morphological measurement, relative size (usually expressed as Equivalent Spherical Diameter, or ESD) derived from the forward-scatter signal. In addition to this simple morphological measurement, the flow cytometer can only characterize cells

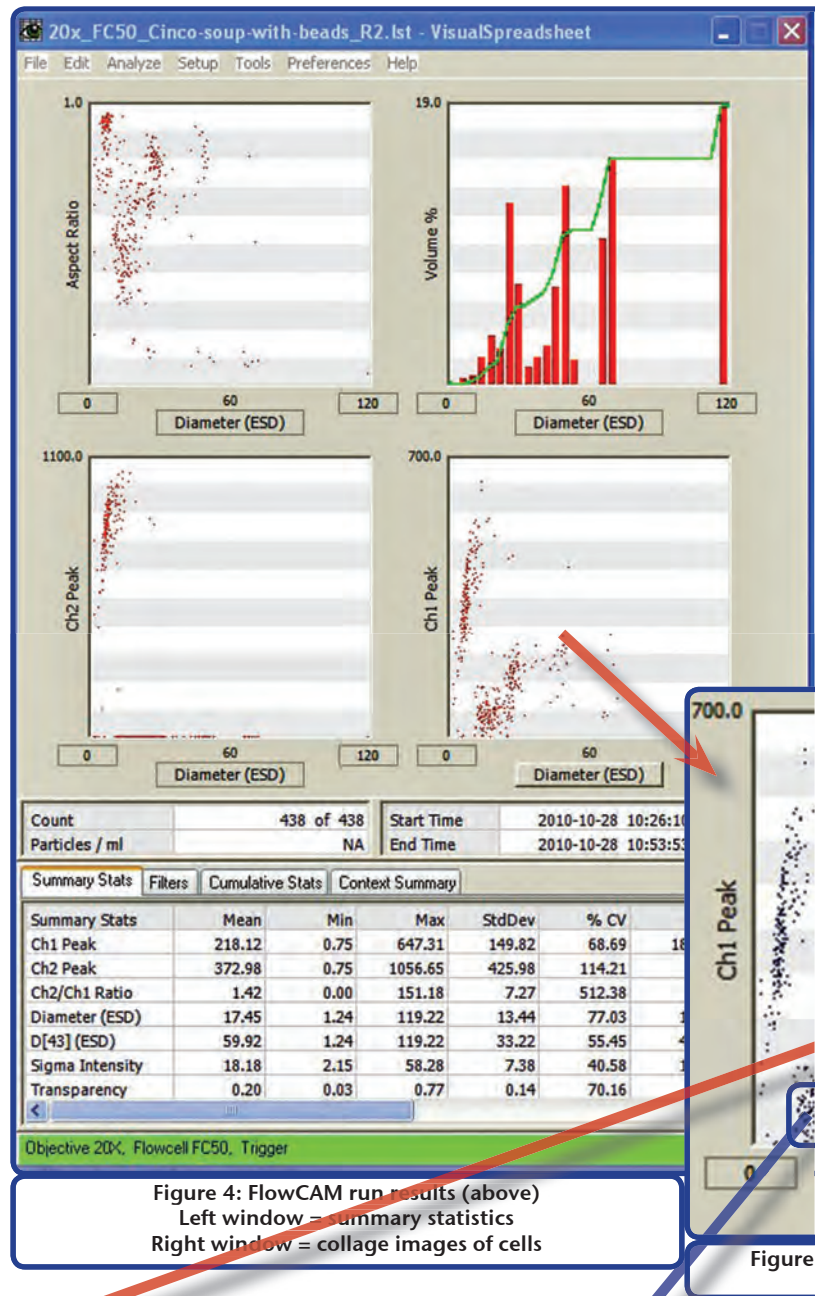

Figure 4: FlowCAM run results (above)  
Left window = summary statistics  
Right window = collage images of cells

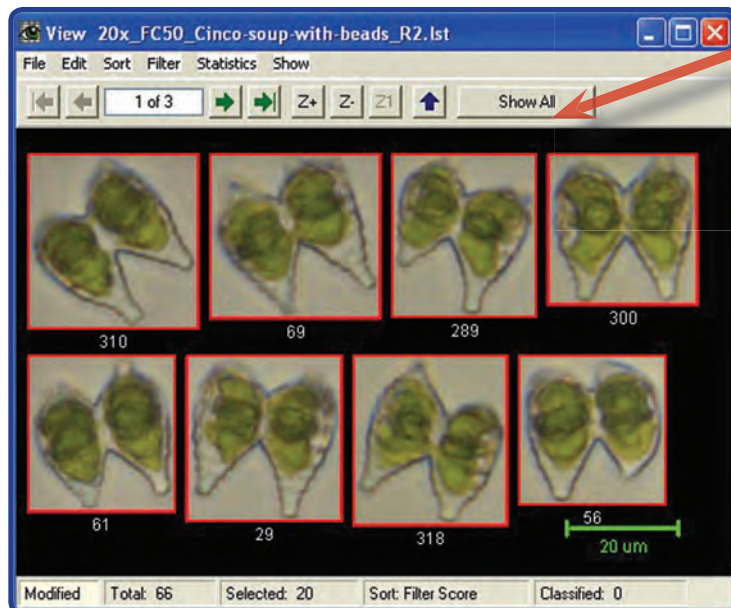
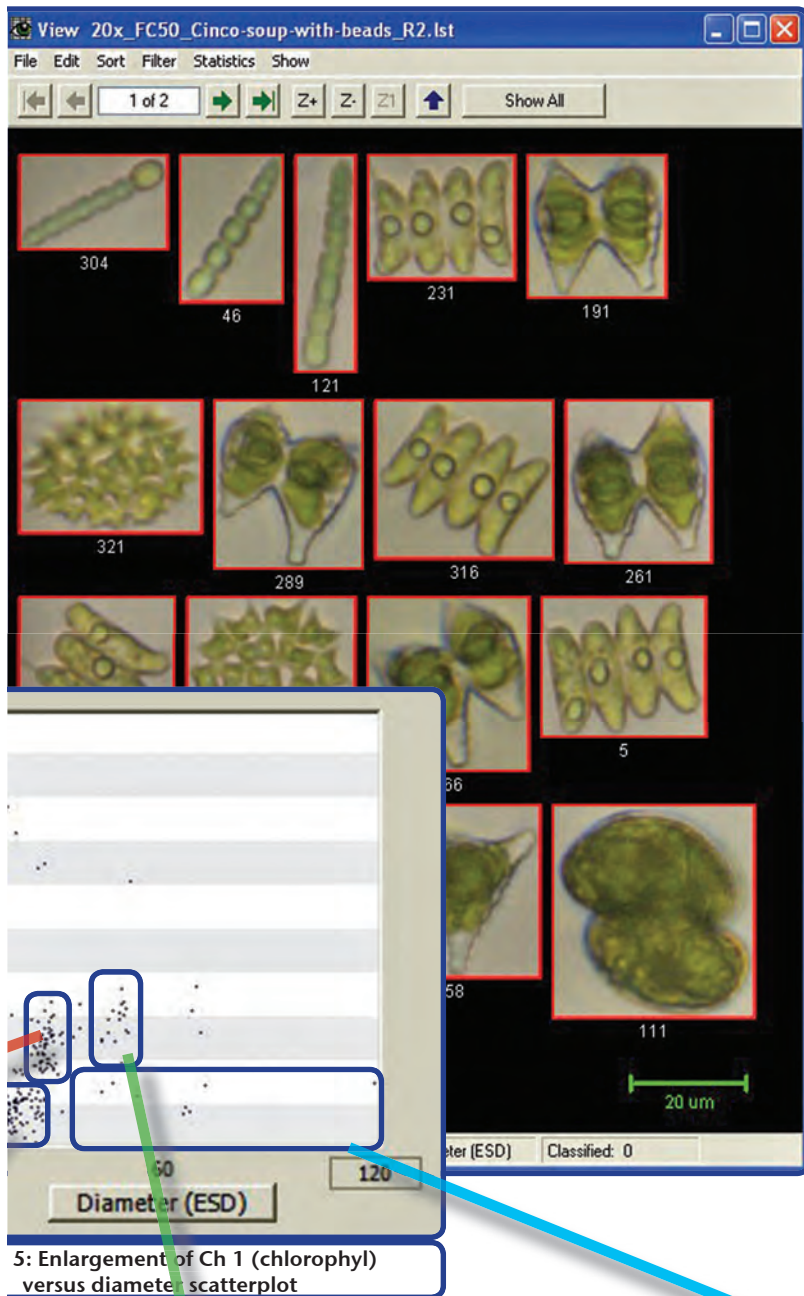

Figure 6: *Staurastrum* cells isolated by VisualSpreadsheet statistical classification



Figure 7: *Scenedesmus* cells isolated by VisualSpreadsheet statistical classification



5: Enlargement of Ch 1 (chlorophyll) versus diameter scatterplot



Figure 8: *Cosmarium* cells isolated by VisualSpreadsheet statistical classification

based upon their “spectral signature”, by collecting fluorescence signals in different narrow wavelength “bands” to approximate a continuous electromagnetic spectrum as might be collected by a spectrometer.

## Example

A sample of mixed algae cultures was run through FlowCAM to demonstrate how the instrument and software use both “morphological” and “spectral” processing to characterize algae. The system was run in “Fluorescence Trigger” mode, whereby the camera is only triggered to grab an image when a fluorescence event occurs upon laser excitation. In a sparse sample, typical of ocean or lake water, this insures that all particles of interest (living algae) are captured, while non-fluorescing particles such as detritus or sediment pass without being captured. For non-fluorescing organisms (heterotrophs) and other particles, FlowCAM can also use “Scatter Trigger” mode concurrently with Fluorescence Trigger.

Figure 4 shows the result of a FlowCAM run with this sample. The left side window shows summary statistics, histograms and scatterplots, while the right hand window shows cell images in a collage window, which can be viewed interactively, filtered, and classified by the VisualSpreadsheet software.

The VisualSpreadsheet statistical pattern recognition capability is then used to automatically classify the different types of microorganisms found in the sample. This is done by creating “libraries” of cell images of a particular taxa and storing them (libraries only have to be built once, they may be reused many times over). When the pattern recognition is invoked, the software performs an “n-dimensional” (where “n” is the number of different measurements being considered, up to 26 total) statistical analysis of each particle image to determine which library class (if any) is closest to the particle being analyzed.



Figure 9: *Anabaena* cells isolated by VisualSpreadsheet statistical classification

Figures 6,7,8 and 9 show the results of this automated classification. As previously stated, the algorithm takes into account morphological, gray-scale *and* spectral characteristics of each particle. It will “weigh” those parameters that most clearly define a particular library type, placing more weight on those parameters than on others that are less significant.

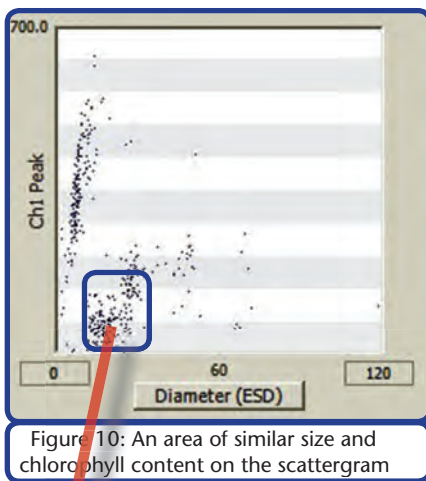

## Conclusion

FlowCAM is a powerful instrument for the automated identification and classification of aquatic microorganisms. By combining the morphological and gray-scale measurements typical of microscopy, the spectral measurements typical of flow cytometry and powerful statistical pattern recognition software, the instrument is able to differentiate algal species whose difference might otherwise be too subtle for other automated analyses. Additionally, FlowCAM can analyze a wider size range of particles (up to 2,000µm) than these other systems. We invite you to contact us, send a sample for analysis, and let us prove how FlowCAM can be a valuable tool in your laboratory!

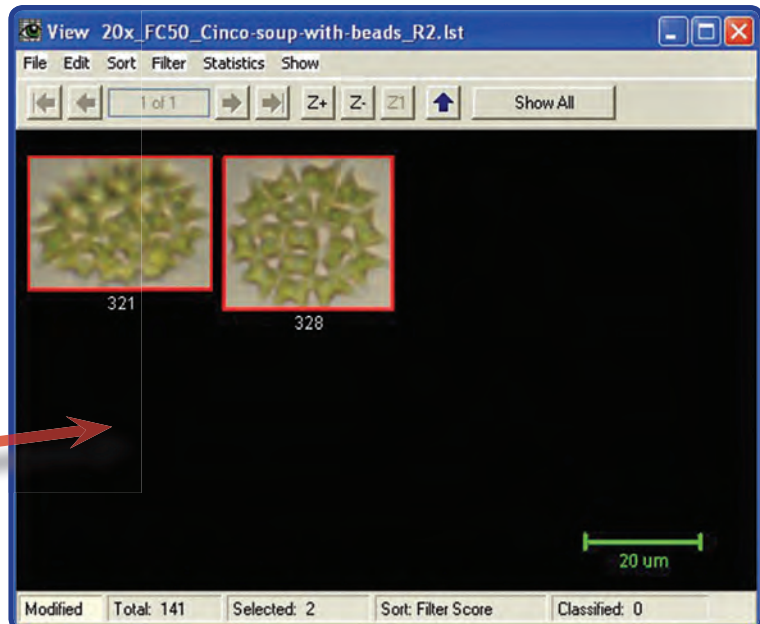

Figure 5 shows a closer view of one of the scatterplots generated from the run, in this case Channel 1 (Chlorophyll) versus diameter. We can see that in this particular example, the four different organism types can almost be differentiated purely based upon size and chlorophyll signature, in which case a flow cytometer might be capable of similar results, as they are all green algae. However, if we closely examine a particular part of this scatterplot (Figure 10), we will find that the region defined in this case actually contains three different taxa (having similar size), namely *Staurastrum*, *Scenedesmus*, and *Pediastrum* (Figure 11).

Because the FlowCAM also takes into account the *morphological* characteristics of the particles in the statistical pattern recognition, it can still isolate the three different species whereas the flow cytometer might not be able to, as they are all green algae.

Copyright © 2011, Fluid Imaging Technologies, Inc.

FlowCAM Specifications	
Parameter	Value (Range)
Size Range (ESD)	1µm - 2,000µm (Count) 3µm - 2,000µm (Shape)
Laser Excitation Wavelength	532nm or 488nm
Emission Filters	Chlorophyll, Phycoerithrin, FITC, PE, FDA, CFDA, CY3, Nile Red
Basic Shape Measurements	Equivalent Spherical Diameter (ESD), Area Based Diameter (ABD), length, width, aspect ratio, area, volume
Advanced Morphology Measurements	Circularity, Elongation, Compactness, Circle Fit, Perimeter, Convex Perimeter, Edge Gradient
Gray-Scale and Color (optional) Measurements	Intensity, Average Intensity, Sigma Intensity, Transparency, Average Red, Green, Blue, R/G Ratio, R/B Ratio, G/B Ratio



For further information contact  
ATA Scientific Pty Ltd

Local distributors for Fluid Imaging Technologies Inc  
www.fluidimaging.com

ATA Scientific Pty Ltd

PO Box 2172, Taren Point NSW 2229

Tel 02 9541 3500 Fax 02 9525 7166

www.atascientific.com.au